



ROMANSTONE®
INTERLOCKING PAVING STONES

CENTURY SERIES™ GRECO™



BETHANY LEDGE

TIMBERWOOD BLEND

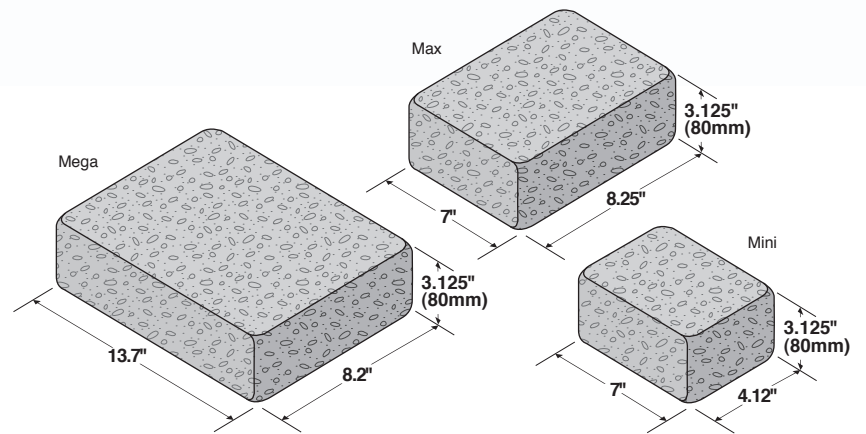

SIZE	UNITS/Sq. Ft.	Sq. Ft./PALLET	UNITS/PALLET	WEIGHT/PALLET
7" x 4.12" x 3.125" (80MM)	5	77	385	2,600 LBS
7" x 8.25" x 3.125" (80MM)	2.5	70	175	2,520 LBS
8.2" x 13.7" x 3.125" (80MM)	1.28	70	90	2,500 LBS

The rectangular shapes offered in Greco create a relaxed, timeless appearance. Its tumbled look and flat surface creates a natural "old-world" cobblestone look. As an added feature, the 80 mm thickness makes Greco an ideal edge restraint and landscaping edging as well.



At 80mm thick, Greco provides added structural integrity to your pavement, making it ideal for driveway and vehicular traffic.

SPECIFICATIONS

Greco is produced using a “no-slump” concrete mix, made under extreme pressure and high frequency vibrations. Unit pavers will meet or exceed the requirements established in the ASTM C936 (standard specification for interlocking concrete paving units). Requirements of this standard include an average compressive strength of 8,000 psi, average absorption no greater than 5%.

LAYING PATTERNS

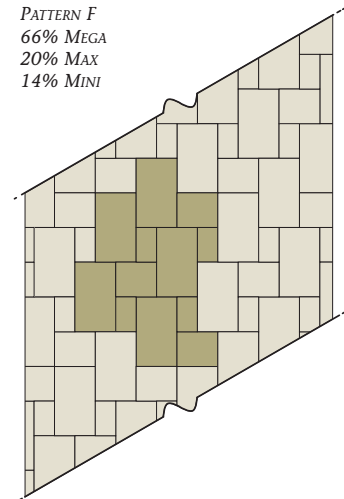
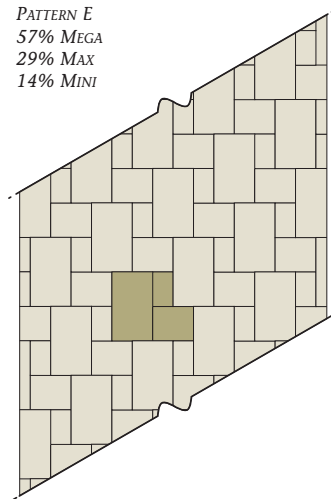
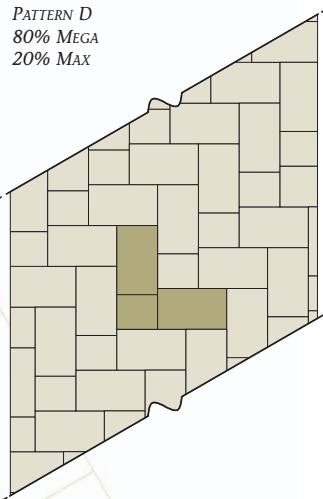
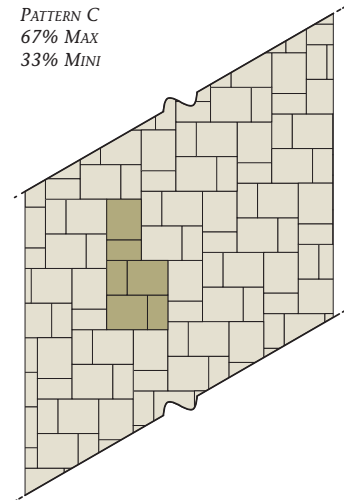
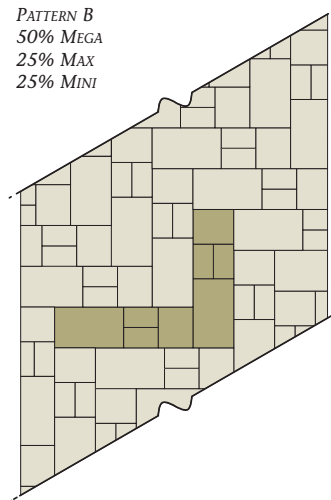
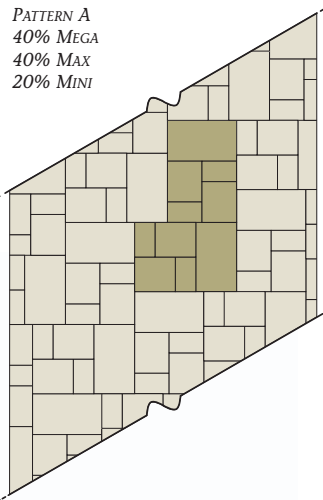

Proudly Distributed by:



www.romanstone.com



For ICPI Technical Notes
visit www.romanstone.com